

Light It Up!!!

QUOTE: "Wow, what a thrill! I was able to help my family with our Christmas lights. Our lights went out and I was able to figure out why."

Melanie Perez -5th Grade Student



Disseminator: DeeDee Conte

E-Mail: dconte@dadeschools.net

School: Bob Graham Education Center

15979th N.W. Avenue

Miami Lakes, Florida 33016

School Phone: (305)557-557-3303

School Fax: (305) 826-5434

Principal: Dr. Robin P. Behrman

TABLE OF CONTENTS	Page
<i>The Project Overview</i>	3
<i>Teacher Tips for Using Science Notebooks</i>	3-7
<i>Science Notebook Lab Cards</i>	8
<i>Lesson 1- Making a Complete Circuit</i>	9
<i>Lesson 2-Learning About Conductors and Insulators</i>	10-12
<i>Lesson 3-Parallel and Series Circuits</i>	13-16
<i>Lesson 5-Learning about Switches</i>	17-18
<i>Lesson 6-Constructing a Flashlight</i>	19-20
<i>Lesson 7-Wiring and Lighting the House</i>	21-22
<i>References for Teachers</i>	23
<i>References for Students</i>	24
<i>Glossary</i>	25
<i>Sunshine State Standards –Science Strand</i>	26
<i>Overall Value, Staff, Resources</i>	27
<i>Student Picture</i>	28

CURRICULUM AREA (S): Science, Language Arts

QUOTE: “Wow, what a thrill! I was able to help my family with our Christmas lights. Our lights went out and I was able to figure out why.”

Melanie Perez
5th Grade Student Bob Graham Education Center

TITLE OF PROJECT: “Light It Up”

(A unit linking science notebooks through Inquiry Based Science)

THE PROJECT: “Light It Up” is a meaningful project that builds fundamental concepts in the physical sciences through direct experience with electrical circuits and through technological design projects. “Light it up” makes use of electrical “stuff” such as wires, bulbs, and batteries, and includes investigations that are both useful and fun. This unit demonstrates the importance of integrating science notebooks and writing through inquiry based science. Students are first introduced to the basic properties of electric circuits as they discover ways to light a light bulb. Next students learn about conductors and insulators and symbols used to represent the parts of a circuit in circuit diagrams. Students also explore different kinds of circuits, and learn about switches. The principles of technological design are used when students design and construct a flashlight and wire a cardboard house. Technology will be integrated throughout the unit as students research and explore the internet to find answers to their questions. Students will also have an opportunity to choose from numerous projects of their choice relating to electricity. Students will explore and research their chosen project and create a power point presentation. If technology is not available or time prevents the project power points could be omitted. This unit will help students further their knowledge and understanding of electricity and enhance their writing and technology skills.

In this science inquiry, students will do the work of real scientists-actively exploring, recording their observations in a science notebook, conducting investigations, collecting data, processing data and building explanations based on evidence. Students write, draw, measure, graph and calculate their way to understanding science concepts as they work through their science notebook activities. The learning cycle, the process of focusing, exploring, reflecting, and then applying as a systematic means of students conducting inquiry based learning, and the interactive notebook is an excellent way of promoting the learning cycle. The primary goal of this project is to demonstrate student learning and conceptual understanding of science concepts through science notebooks and inquiry based science.

Teacher Tips for Using Science Notebooks for Inquiry-Based Science

The interactive science notebook (ISN) is a perfect opportunity for science educators to encapsulate and promote the most cutting-edge constructivist teaching strategies while simultaneously addressing standards, differentiation of instruction, literacy development, and maintenance of an organized notebook as laboratory and field scientists do. Students then have a packaged notebook representing all of their learning throughout the year.

The notebooks that work best are the 200 page composition journal or 3 prong folders with pockets. Students are asked to bring in a roll of clear tape during the first week of school, and this tends to be enough to use in the classroom throughout the school year. The tape is placed in a plastic box on their classroom tables along with colored markers, pencils, and sticky notes. Having the box in such an accessible place for students allows them to efficiently fold and tape any handouts to the appropriate notebook pages. When setting up the notebook, students are required to label and date each page based on the assignment or lesson. Handouts can be cut and taped to pages, or taped so they flip up as pages of a clipboard notebook might. The first page of the notebook is skipped and is used to indicate scores for notebook assessments. At the end of the year a student generates a condensed foldout table of contents to be taped to that front page. Students tape an assessment rubric to the inside cover of the notebook for quick and easy reference for both the teacher and student.

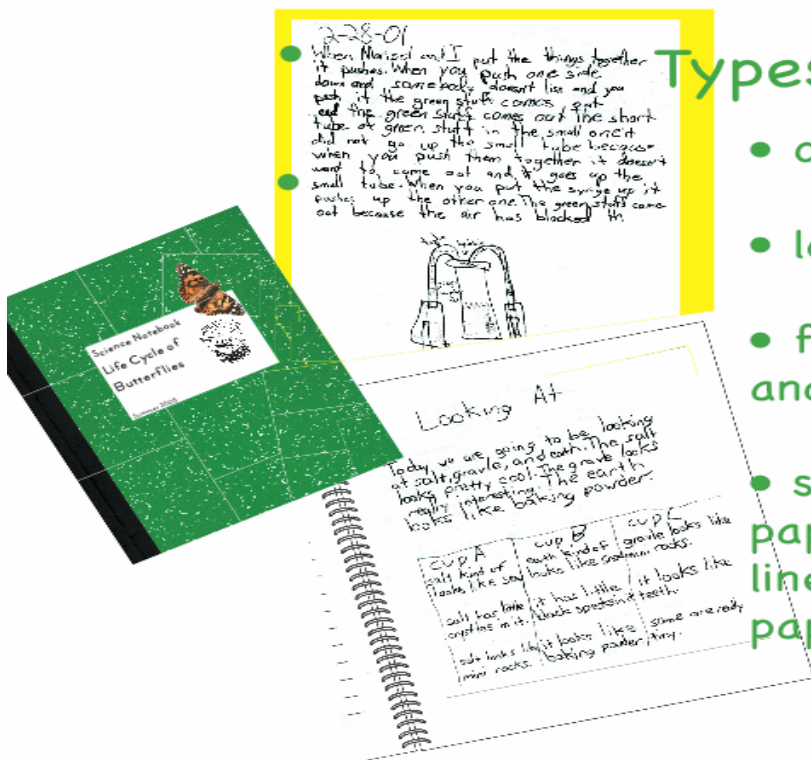

Types of Notebooks

- composition book
- looseleaf notebook
- folders with pockets and fasteners
- stapled construction paper around plain, lined and/or graph paper

Cup A	Cup B	Cup C
salt kind of	earth kind of	gravel looks like
looks like sand	looks like broken rocks	
salt has little crystals in it	it has little black speckles	it looks like
salt looks like mini rocks	it looks like baking powder	some are really

Notebook Entries

Looking At

Today we are going to be looking at salt, gravel, and earth. The salt looks pretty cool. The gravel looks really interesting. The earth looks like baking powder.

cup A	cup B	cup C
salt kind of looks like sand	earth kind of looks like snow	gravel looks like mini rocks.
salt has little crystles in it.	it has little black specks in it.	it looks like teeth.
salt looks like mini rocks.	it looks like baking powder.	some are really tiny.

Investigations

date 3/5/02



A	B	C
salt	earth powder	gravel
white	white	assorted
pours fast	pours a bit slow	pours fast
small pieces	small pieces	medium pieces
looks like sand	looks like flour	looks like rocks
has black spots	has different shapes	has different shapes
has crystalized pieces	has black spots	has different shapes



- notes and lists
- drawings
- charts
- tables
- graphs
- written observations

When setting up the notebook, students are required to label and date each page based on the assignment or lesson. Handouts can be cut and taped to pages, or taped so they flip up as pages of a clipboard notebook might. The first page of the notebook is skipped and is used to indicate scores for notebook assessments. At the end of the year a student generates a condensed foldout table of contents to be taped to that front page. Students cut and tape an assessment rubric to the inside cover of the notebook for quick and easy reference for both the student and teacher. The rubric is used for assessments throughout the year and each point is assessed with a different color marker to show trends in performance from one notebook check to another.

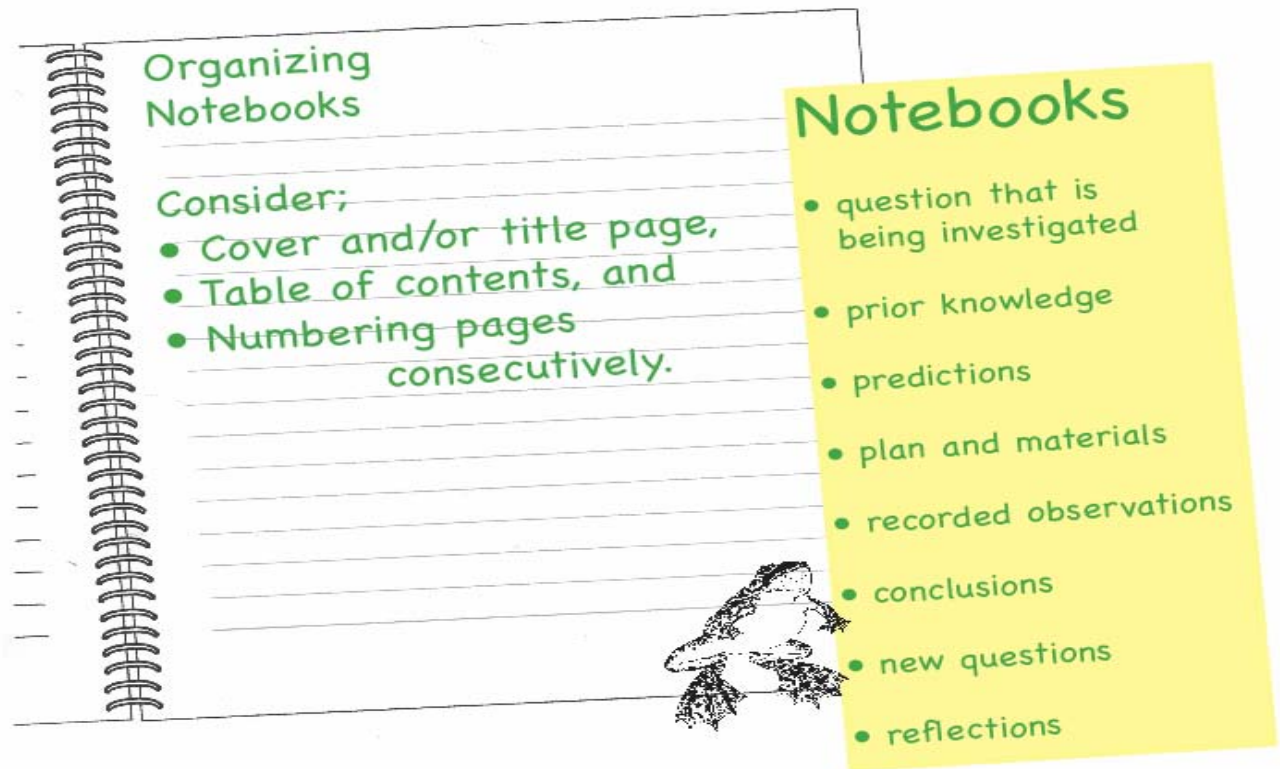

The ISN is broken down into a right-side and left-side page technique in which students create “input” on the right-side pages (lecture notes, lab notes, reading notes, etc.) and then process that input in a meaningful and personalized manner on the left-side pages in the form of “output” (Young 2003). Left-side output ranges from the creative arrangement of input information into predesigned or original graphic organizers for visual and spatially adept students to acrostic and 3-2-1 review. For an acrostic exercise students are encouraged to write a statement about the content of study that starts with the first letter of a word or statement. For 3-2-1 Review, students are asked to list three things you learned, two things you wonder, and one symbol that captures the essence of the topic of study. Another strategy to 3-2-1 Review approach is to ask students to invent and respond to their own categories.

In essence any summary activity that promotes higher order thinking can be considered an output activity, and students are also free to invent their own form of output with teacher approval.

Left Side- Output	Right Side-Input
<i>This is where you personally connect with the information on the attached right side</i>	<i>This is where you put incoming information notes, data and so on</i>
<i>Date ,label, and number each page Do output exercise such as:</i>	<i>On the right side you will: Date ,label, and number each page Write down information from:</i>
Summary Techniques CD Label	lectures
321 Reviews First Word Acrostics Graphic Organizers	Readings
Tables/ Graphs Flow Charts, Word Webs	Presentations
Mind Maps, Diagrams Venn Diagrams	Videos
Creative Stuff Pictures/Drawings	labs
Brainstorming, poems ,raps, songs cartoons, weird thoughts	

- 3-2-1 Review Example - Ask students to “list three things you learned, two things you wonder, and one symbol that captures the essence of the lesson.
- In essence any summary activity that promotes higher order thinking can be considered output.
- CD Labels- student read information or collect class input reflected as what they have learned, inventing the name of a band, album title, soundtrack titles based on the topic.
- Students show that they understand the content of the lab or assignment in a way that works for them.

One particularly popular form of output that my students enjoyed is the CD label. Students read information or their collected data as input and then create a CD label reflecting what they’ve learned, inventing the name of a band, album title, and track title based on the topic. In the unit “Light it Up” students brainstorm to develop a list of songs relating to electricity. For example “Electric Slide,” You Light of My Life.”

I have also found Science notebook cards to be a helpful tool that teachers may use to help increase organizational skills, and enhance writing . Teacher creates cards for students to keep and refer to in their science folder. An example of science cards are as follows:

Science Lab CD

- 1. Collect and read Science lab notes.*
- 2. Discuss and choose songs relating to science lab for CD track.*
- 3. Invent the name of your band.*
- 4. Select a name for CD cover relating to science tour.*
- 5. Create a CD cover for track.*
- 6. Be creative and original.*

Example: Topic- Electric Circuits

Song: “ Electric Slide”

“You Light Up My Light”

Science Notebook

- 1. Date and Time*
 - 2. Outcome sentences choose two from the following to write about.*
 - I learned.....*
 - I am surprised.....*
 - I wonder.....*
 - The important thing about.....*
 - I like.....*
 - I now understand.....*
 - 3. Add a drawing to your science entry to illustrate the science lab.*
-

Science Notebook Feedback

- 1. Exchange science notebooks with the person next to you.*
 - 2. On a post-it give positive feedback regarding the student’s work.*
 - 3. Make comments regarding what you liked about the entry.*
 - 4. Give suggestions how the student could improve the entry.*
 - 5. Pass the entry back to its original owner.*
 - 6. Read feedback and if you like you may volunteer to read aloud to class.*
-

“Light It Up” Unit Lessons

Lesson 1-Description: Making a Complete Circuit

Students will predict and explore ways to light a bulb using one wire, a bulb and one battery. Students are challenged to problem solve to find the four possible ways to light the bulb and make a complete circuit. The circuit is established when there is a continuous path for electricity to travel from one end of the D-Cell back to the other end.

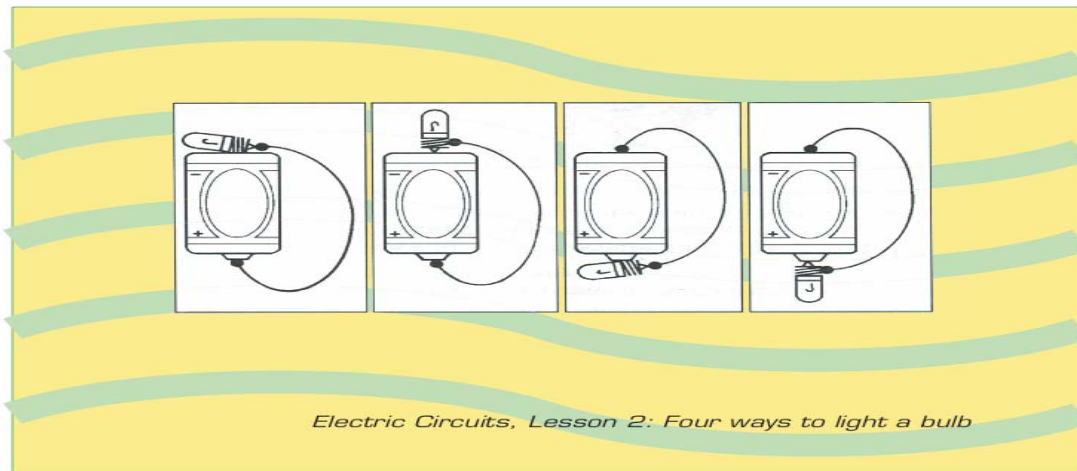

Procedure:

1. Ask your students to get out their notebooks. Remind students that they will be keeping a record of their findings and questions throughout the lessons. The record will be writings as well as drawings.
2. Students will turn to the first page of their notebooks and write the date on the page. Then have students draw a picture of a light bulb. Students will refer to their notebooks to gain conceptual understanding of the lessons and enhance their writing skills.
3. Students will be given a tray with one wire, one D-cell battery, and one bulb. Challenge students with their partners to light the bulb and to find four different ways to light the bulb.
Have students draw pictures of the different ways the bulb lighted on one page of their notebook and of several ways it did not light on another page.
4. Students should complete their notebook entries by writing what they found interesting and what surprised them about lighting their light bulb and making a complete circuit
5. Student Feedback and Evaluation- Exchange student notebooks with a person at your table. On a post-it give positive feedback regarding the student's work. Make comments relating to what you liked about the work and possible ways a student might improve their product. Students read their feedback and have the opportunity to read it out loud to the class if they choose.
6. Similarly, the students' drawings of the ways the bulb lights show how well they can observe intricate parts and how much they understand about electricity. They can provide a baseline against which to compare later drawings.

Lesson 2-Learning about Conductors and Insulators

The Investigation

The students will build a device to determine if something is a conductor, test to determine conductors and nonconductors, and make insulated wire. The device is simple to build, helps students understand the concept, and costs almost nothing.

Concept

- Electricity will travel through materials known as conductors. Metals are good conductors. Nonmetals are poor conductors.
- Insulators are materials through which electricity does not flow-at least not in detectable amounts.

MATERIALS FACILITIES: Student tables work best for this unit, however student desks could be turned around and put together to enable students to work in cooperative learning groups.

Materials for class of 30

- 15 -D-cell batteries
- 15 - bulbs (micro-lamp)
- 1 roll (100feet #22 coated hook up wire)
- 15 spring type clothespins
- 15 large paper clips
- Masking tape
- Student Science Notebooks

Put the following materials in a plastic bag- 1bag per two students

- 1-D-cell batteries
- 1 - bulbs (micro-lamp)
- 1 wire
- 15 spring type clothespins
- Masking tape

Things to Test:

- 15 small bag of assorted objects (objects may vary)

golf tee

1 inch piece of soda straw

brass screw

paper clip

aluminum 1 inch screening

plastic screening (1 inch square)

1-inch piece of chalk

wooden pencil stub (without eraser, lead exposed at both ends)

brass paper fastener
wire nail
aluminum nail
marble
1- inch piece of pipe cleaner
1- inch piece of bare copper wire
1- inch piece of bare aluminum wire

Procedure

- “You have seen that electricity will move from one terminal (end) of a battery to the other along a wire in lesson 1. The wire is a conductor. It conducts electricity.” What other items would be good conductors of electricity?
- Make a list of items you would like to test from our classroom.
- Have one student from each group pick up materials.
- Using the materials in the bag build a tester to test for conductors and insulators.
- Students will problem solve together to build a circuit tester to test for conductors and insulators.
- After students have had time to make a tester choose a student to demonstrate how to build a tester. Place the base of the bulb into the clothespin. Snuggle one end of the foil against the base of the bulb. The clothespin should hold it in place. Tap the other end of the foil securely to the positive end of the battery. Test the circuit by touching the tip of the bulb against the negative end of the battery. The bulb should light. I have found that students will be able to put this together without a demonstration.
- Select objects from the bag of stuff making predictions which objects will light the bulb and which objects will not...
- Ask the students to use their circuit tester device to see if an object such as a paper clip can be part of the circuit. What does it mean if the bulb lights when you touch the wires to the ends of the paper clip? Help students see that if the bulb lights, it means the electricity had to travel through the paper clip. Use your circuit tester on something that does not conduct, such as a piece of chalk, and discuss why the bulb does not light.
- Have each student take their set of assorted materials and create a list of these items in their notebooks.
- Using the list, ask students to make a chart with three columns beside the list , and to predict whether they think the light will be on or off when the item is included in the circuit. An example is shown below.

Predictions

<i>Item</i>	<i>Light On?</i>	<i>Light Off?</i>	<i>Experiment Result</i>	Notes

- Have each student use their circuit tester to test their set of assorted materials. Encourage the students to test materials they find in their desks as well. Emphasize the importance of recording the things that don't cause the bulb to light, as well as those that do.
- About 5 minutes before the end of the period, have students return their items to their boxes and return the materials to the storage area.
- Have students write the words "insulator" and "conductor" in their notebooks under their lists, and the class definitions, then have them draw a conductor and an insulator next to each definition.
- Students will write in their notebook things that surprised them about conductors and insulators.

- Students will add their prediction sheet to the left hand side of their science notebook entry.
- Students will share their results with the class and graph the class results as a math extension.

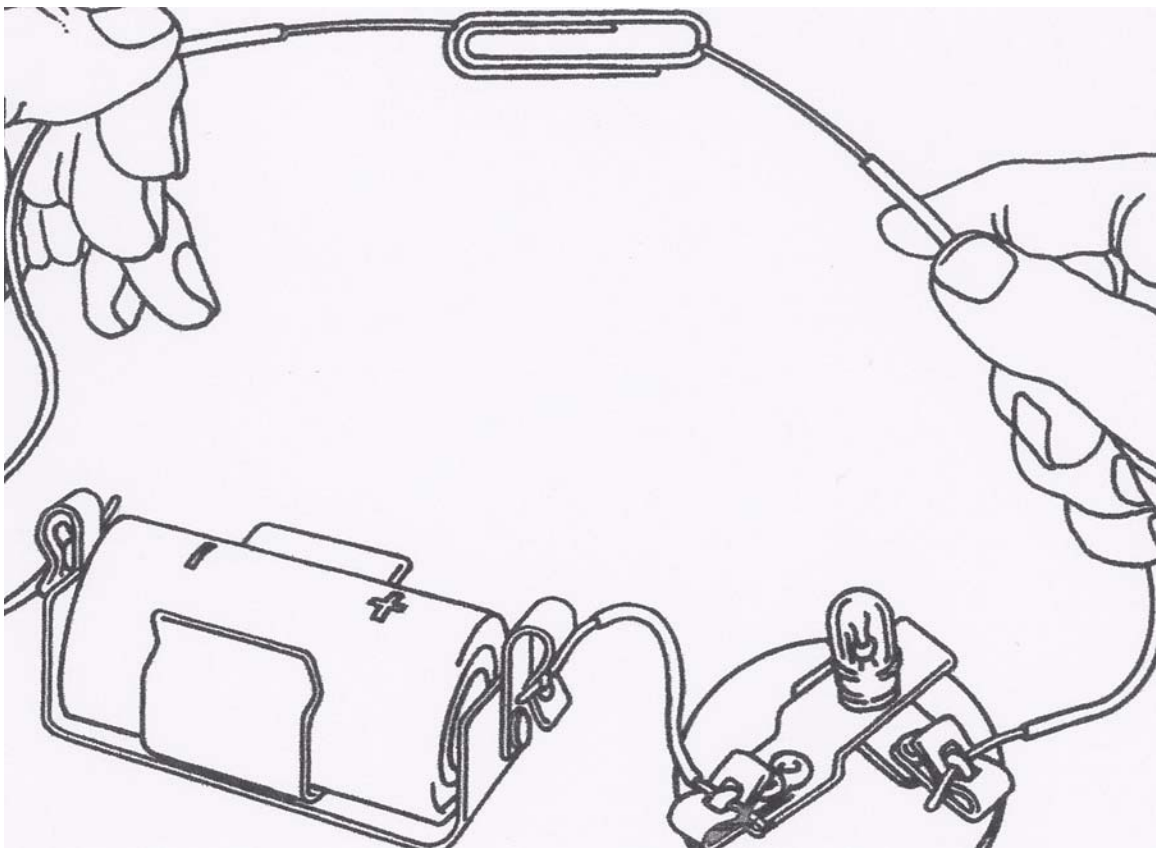

Lesson 3-Parallel and Series Circuits

There are two optional lessons to choose from dealing with parallel and series circuits. The choice selection depends on your materials and personal preference. Both lessons can be taught if time permits for reinforcement and understanding of physical science strand.

Objective: to learn about parallel and series circuit through hands-on manipulation of bulbs, batteries, and wires.

Background Information

With a series circuit, more than one electric device may be powered by a single energy source. The electric current in a series circuit flows along one path. When the path is broken, electricity will not flow. In a parallel circuit, the current splits to flow along two or more paths. If one of the paths is broken, the electric current continues to flow along the other path. Think about the wiring in your house. When you have two different lamps plugged into one receptacle, one lamp being turned off or one bulb burning out does not make the other lamp go off. This show that these two lamps are in a parallel circuit arrangement. On the other hand, think about the old Christmas tree ornaments, where one light burning out meant that the whole string went out. Those lights were in a series arrangement.

Materials:

- 2 D batteries
- 4 flashlight bulb-mini bulb
- 2 pieces of aluminum foil (folded into strips)
- clothespin
- tape

Procedure:

1. Examine the illustrations. Which circuit do you think will produce the brightest light? Record your prediction in your science notebook.
2. To test your prediction, assemble each circuit as shown. Wrap the foil strip around the base of the bulb and then use a clothespin to hold the base, as it will get hot.
3. When the pairs have constructed each circuit, have students record the results in their notebooks. Have them draw the circuits in their notebooks and keep track of the brightness of the bulbs in each case.
4. Help students to judge a way to judge the degree of brightness of the bulb. The class can decide that a simple one bulb, one battery brightness is the standard. Students can then judge another bulb's brightness by comparing it with "the standard" bulb, classifying it as brightness by comparing it with the standard bulb, classifying it as "dimmer," about the same," or "brighter" than the standard bulb.

- Record your observations in your science notebook on the right-hand side of your notebook. On the left side do the “3-2-1 Review” Example - Ask students to “list three things you learned, two things you wonder, and one symbol that captures the essence of the lesson.”

Parallel Circuit

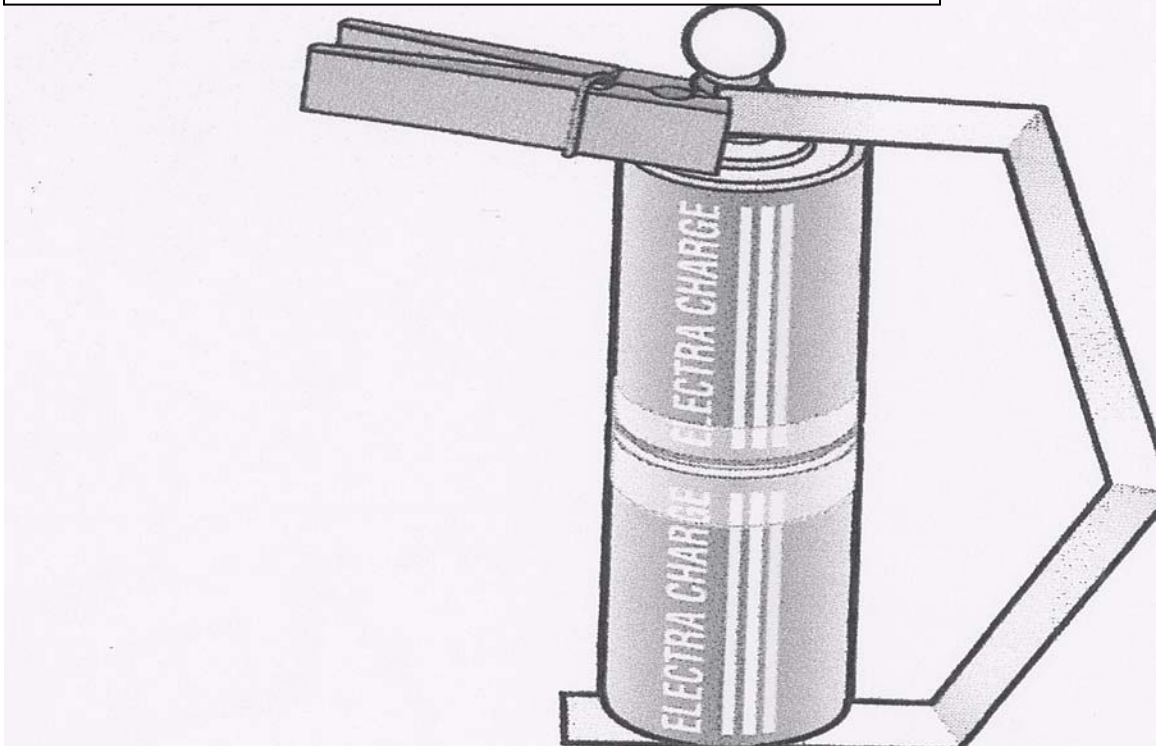
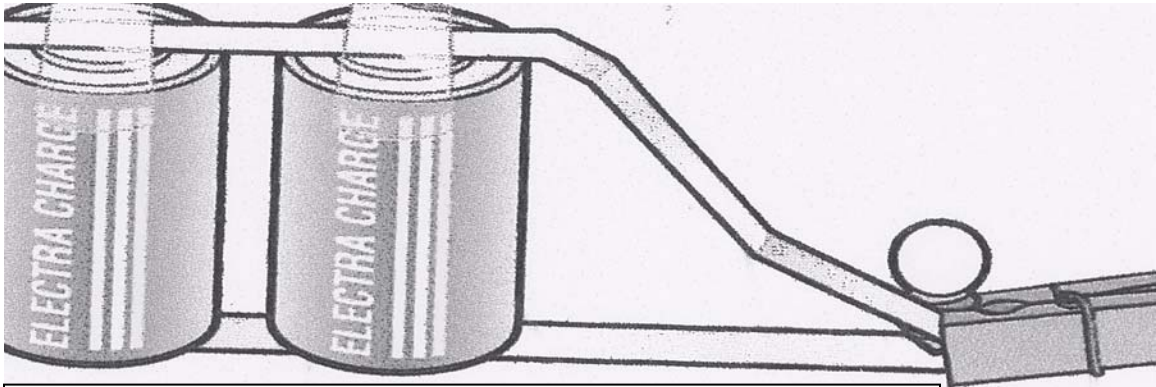

Series Circuit

Explanation:

Battery power is measured in voltage. When batteries are connected in a series circuit, their voltage is added. For example, two 1.5 volt batteries will produce 3.0 volts. When

batteries are connected in a parallel circuit, their voltage is not added, so two 1.5 volt batteries will still produce 1.5 volts.

Lesson 4-Investigation- Compare and Contrast Series and Parallel Circuits-Task 1

Skills incorporated problem solving, research skills, and reasoning.

- ***Science Concepts:***
- An electric circuit is a pathway along which electricity flows.
- A circuit with only one pathway for current flow is a series circuit.
- A circuit that splits into that splits into two or more pathways before coming together at the battery is a parallel circuit.

Materials:

- 1 circuit base
- 2 D-cells, alkaline
- 1 cell holder
- 1 switch
- 2 light bulbs in holders
- 2 long wires, 20 gauge, and 30 cm.
- 4 short wires, 20- gauge, 15 cm

Students are given a real world challenge. As a team they have to create the best circuit possible for holiday lights.

Setting the Scene: The Investigation

During the winter holiday season people like to decorate their homes, businesses, and streets with lots of little lights. Last year a company called Light-Weight-Enterprises sold lots of long strings of lights and made a lot of money. But it wasn't long before Light-Weight started getting complaints from the people who bought its strings of lights.

One customer complained, "If one light burns out, all of the other lights go off, too. Then I have to test all the lights to find the bad one. That takes too long. I want my money back!"

The people at Light-Weight Enterprises had a problem. They needed a string of lights that would not all go off when one light bulb burned out. The boss called her workers together and gave them instructions. "I want you to research this problem and make a recommendation about how we should be manufacturing these lights. I want hard evidence to show what kind of circuit we have been using that the customers are complaining about and what kind of circuit we should start using to solve this problem."

1. Design a circuit which can light two bulbs brightly with just one battery.
2. Your groups challenge is to create as many circuits as you can to solve this question. (HINT: There are eight ways you can light two bulbs brightly with just

- one battery. As a team working together design, create and draw as many circuits as you can to solve the challenge.
3. Discuss and problem solves with your group and draw schematic diagrams of your circuits.
 4. Using the materials given to you create the circuits you have designed. Record your findings in your science notebook.
 5. Choose a person to draw one of your circuits on the board.

Task 2 – Sharing Your Results

1. Draw your diagram on the board.
2. Compare and contrast the circuits and designs of the other teams.
3. How are they similar to your circuit?
4. How are the other circuits different?
5. Do all the circuits work in the same way?
6. Record your answers in your science notebook.

Task 3-Comparing and Contrasting Series and Parallel Circuits

1. Compare and contrast the two circuit designs series and parallel. How are they alike? How are they different
2. Describe when a series circuit might be the best design. Why?
3. When would a parallel circuit be the best design? Why?
4. Record your answers in your science notebook.

Conclusion Comparing and Contrasting Circuits

The brightness of the two bulbs in series and the two bulbs in parallel is visibly different. It seems logical that more energy is used for the parallel bulbs than for the series bulbs because more light is emitted. Discuss with your partner why you agree or disagree with this statement and why?

Science Notebook

1. Using your science notebook cards complete an entry for your series/parallel circuit science investigation.
2. Add drawings for clarity of your entry.

Computer Investigations

1. With your partner discuss things you would like to research relating to electric circuits.
2. Write down questions you have for further study and knowledge.
3. Your team will have an opportunity to explore your questions on the computer next class session.

Lesson 5-Learning about Switches

The Investigation: Many common electrical devices use both parallel and series circuits. A flashlight, for example, uses a series circuit for maximum brightness. In this lesson students think about these concepts by drawing a plan for a flashlight. To make the flashlight, students need to learn about another important element of complex circuits the switch. Flashlights come in many shapes and sizes, but they have several things in common. They have a power supply (the batteries), a light bulb, wires or pieces of metal to complete the circuit, and a switch.

Science Concepts:

- Students construct a switch and learn why switches are important.
- Students apply what they have learned about series and parallel circuits to devise a plan for a flashlight.

Materials: For each student

- ***1 D-cell battery***
- ***1 battery holder***
- ***1 bulb***
- ***1 bulb socket***
- ***3 6 inch pieces of wire***
- ***1 science notebook***

For every two students

- ***2 6-inch pieces of wire***
- ***1 paper clip***
- ***3"x5" index card***
- ***2 brass paper fasteners***
- ***2 brass paper fastener washers***
- ***2 Fahnestock clips***

Preparation

1. Before class, make a simple switch according to the diagram. (scan figure page 70)
2. The paper fasteners should not touch each other on the back side of card. Use a piece of masking tape, as shown in Figure 12-1 to hold the ends of the paper fasteners apart.
3. Put the switch in a circuit that has one bulb and one battery, all in series as illustrated in the drawing.

Procedure

1. Start the class by telling the students that today's task is to come up with a plan for a flashlight. Ask students what they think are the important parts of a flashlight. As the students make contributions, write them on the chalkboard or on chart paper in one of two columns: "Necessary" and "Useful."
2. After a few minutes of discussion, the items in the "necessary" column should include:
 - A power source (the battery)
 - A light (the bulb)
 - Wires or conductors
 - a way to turn the flashlight off and on (switch)
 - that it be portable
3. Now that students have had a chance to think about the components of a flashlight Tell them they will have a chance to build their own. Tell each pair that before they can construct a flashlight; they will need to figure out a way to turn the light on and off. To give them a starting point, show them the paper clip switch you have made. Demonstrate how to use it to turn the light on and off. 4. Invite the students to make their own switch. They could make one like you demonstrated Or you could give them the opportunity to invent their own

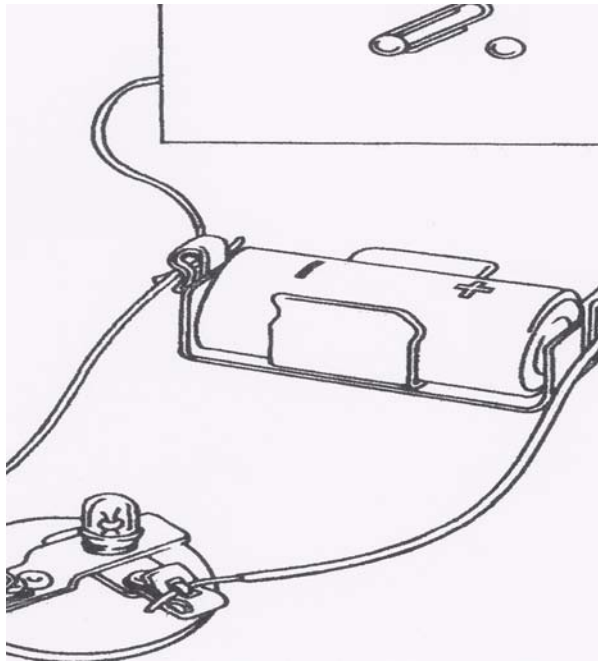

Example of a paper clip switch.

Extensions:

Ask students to think about where they have seen switches. Some examples are the ignition switch on a car, the light switch, the switch on a hair dryer etc. Have students go on a "switch" scavenger hunt. How many kinds of switches can they find? Ask them to make a list to share with the class.

Lesson 6 – Constructing a Flashlight

The Investigation: Building on the knowledge of previous lessons, students incorporate the switch they have made into a flashlight they have designed. As students share the flashlights they have made, they also review series and parallel circuits.

Science Concepts

- Students discuss the similarities and differences between series and parallel circuits.
- If students use a series circuit in their flashlight, the bulb will be brighter.
- If students use a parallel circuit in their flashlight, the bulb will last longer.



Materials:

For Each Student

- 1 student notebook

For every two students

- 1 D-cell battery
- 1 battery holder
- 1 bulb
- 1 bulb socket
- 3 6 inch pieces of wire
- 1 paper clip switch

For every four students

- 4 sheets of 8 1/2" x 11" construction paper
- 1 pair of scissors
- 1 roll 3/4" masking tape
crayons or markers

Procedure:

1. Distribute the materials and review with students the essential components of a flashlight.
2. Tell them that now they will be given time to build their own flashlights. Have students use their designs to build their flashlight.
3. Have students pairs grouped so that two pairs can share one pair of scissors, one roll of masking tape, and several sheets of paper.
4. As students construct their flashlights, make sure they are working together and have the materials they need.

5. As students finish, ask them to share with you how the flashlight is turned on and off.
6. Have students make drawings or circuit diagrams of their flashlights in their notebooks. Choose an item from the notebook cards to write a notebook entry.
7. Students should decorate their flashlight with markers or crayons.
8. About 5 or 10 minutes before the end of the period, have students clean up. Make sure they leave their flashlights intact, but have them put away all materials.

Final Activities

Ask students to share with the class the flashlights they have created. This could be an opportunity for an oral presentation by the different pairs. Their presentation could include a description of the process of building flashlights, any difficulties overcome, a demonstration of how the flashlight works, and a large version of the circuit diagram drawn on the board.

Evaluation-Performance Assessment

The flashlights that students constructed reveal what students understand. Here are some specific things to look for:

- Is the student able to construct the switch and put it in the circuit so that it turns the light on and off?
- Can the student wire the circuit so that the batteries are in series or parallel?



Lesson 7 Wiring and Lighting the House

Students use their plans to wire and light a cardboard house. By the end of this lesson students will have learned some important information about how a real house is wired.

Science Concepts:

- Students apply what they have learned about series and parallel circuits.
- Students use all the skills and information they have gained to work in teams to wire and light a house.

Materials:

For each student

1 student notebook

For every four students

1 cardboard box

4 storage bags, each containing:

1 D-cell battery

1 battery holder

1 bulb

1 bulb socket

4 6inch pieces of brass paper fasteners

1 roll of 1 “masking tape

2 paper clip switches

1 pair of scissors

For the class

1 roll of wire

1 wire stripper

2 screwdrivers

30 3”x”5 index cards

1 box of paper clips

1 box of No. 3 brass paper fasteners

1 box of brass paper fastener washers

Crayons, paints, or markers

Procedure

1. Tell students that they will be wiring the box as though it were a house. Organize them in teams of four.
Tell students that their task is to organize their house so that there is a light in each room. As students discuss this, write essential questions on the board. Some of those questions are listed below.
 - Where will the lights be placed?
 - Where will the switches be placed?
 - Where will the D-cell batteries be placed?
 - How should the switches, bulbs, and D-cell batteries be connected so that the bulbs burn the brightest?
 - Where will the wires be placed?
2. Ask students to draw a copy of their wiring plans in their notebooks. These drawings will give them a record and will give you an opportunity to see how each student is doing.
3. Students will use their plans to begin wiring their cardboard houses. Point out that the screwdriver can be used to punch a hole in the cardboard to allow wires to pass through the “wall” of the house. Warn students to be careful when using it. The masking tape can be used to hold things as needed, such as wires along a wall and the switch to the wall. Have materials to available for students to make additional switches.
4. As students finish, ask them to make a wiring diagram of the actual wiring in the house and to put it in their notebooks. Have them compare their actual plan with their original design.
5. When students have finished wiring and lighting, have them decorate their houses.
6. Clean up.

Final Activities

Have each student group present their house to the class with an oral presentation and a demonstration. Or, have each group prepare a written description of their house. The written description could recount, among other things, the work they did in making their plans, what issues and problems they had to solve in their group, any changes they made as they did the wiring, any problems that arose, and how they were resolved.

References for Teachers:

Butzow Carol M.. “Science Through Children’s Literature”. Teacher Ideas Press, Engle Wood, Colorado, 1989.T

The purpose of this book is to suggest an alternative approach to the teaching of elementary science in light of more contemporary definitions of both reading and science.

Baumgras, Bonnie, “Science In A Box”, The Mailbox Publishing Company.

The book contains 39 complete hands on science units. Supports National Science Standards. Over 75 explorations, Ideas for easy to use reusable kits, promote scientific inquiry.

“Magnetism and Electricity” FOSS Full Option Science System, Lawrence Hall of Science. University of California at Berkeley. Publisher Delta Education.

The Magnetism and Electricity consists of five sequential investigations, each designed to introduce or reinforce concepts to physical science.

Strongin, Herb and “Science on a Shoestring” Second Addition. Addison-Wesley Publishing Company.1991.

“Active Assessment for Active Science” Library Of Congress, 1994.

The book includes compelling discussions of the limits of multiple-choice tests. It seriously challenges the argument that test scores are more precise than any other form of information about children’s learning.

“Electric Circuits” The National Academies, National Science Resources Center, Science & Technology for Children “ Carolina Biological Supply Company 1990.

Electric Circuits, is divided into three parts. Students through hands on lessons will help students answer their many questions by opening the door to the world of electricity. The unit makes us of electrical materials such as bulbs, wires, conductors, insulators, batteries, switches, circuits, and includes investigations that are both useful and interesting.

“Science For All Children” National Science Resources Center 1997.

A Guide to improving elementary science education and science reform. Through studies demonstrates the need for inquiry centered science and performance based assessment.

Young.J. 2003. Science Interactive Notebooks, Science Scope26 (4):44-7

References for Students:

Beasant, Pam. Introduction to Electronics. Tulsa: Educational Developmental Corp. 1985.

This is a simple, but greatly detailed introduction to electronics for beginners. It is very amply illustrated and targeted at the younger reader. The interested student will be able to use it to make use of much of what is being learned in this unit.

Cosner, Shaaron, The Light Bulb. New York: Walker and Company, 1984.

This is a serious book for young readers who are interested in the story of Edison's invention of the light bulb. It provides enough of the details of his struggles and the gritty work involved to give the budding young inventor a realistic view of the tasks that are ahead.

Haber, Lewis .Black Pioneers of Science and Invention. New York: Hardcourt, Brace, Jovanovich, Inc., 1970.

This book traces the lives of black scientists and inventors who have made significant contributions in the various fields of science and industry. Of particular interest to the study of electricity and its applications are the lives of Granville T. Woods and Lewis H. Latimer.

Math, Irwin, Wires and Watts: Understanding and Using Electricity. New York: C Charles Scribner's Sons, 1981.

The book uses experiments and projects that produce actual working models to present the fundamentals of electricity. It goes considerably beyond the content of *Electric Circuit*, introducing the use of simple equations to express Ohms law, detailing the working of a D-cell battery, and explaining a variety of instruments and devices. This book would be of interest to the most advanced and ambitious student

Glossary

- 1. Battery: A device that can produce an electric current as a result of chemical change in it.**
- 2. Circuit: A System that connects electrical devices so that they will operate**
- 3. Conductor: A material through which an electric current can pass.**
- 4. Data: Information, such as that gathered during an experiment.**
- 5. Insulator: A material through which an electric current will not pass.**
- 6. Parallel circuit: An electric circuit in which the components are connected so that the current can follow more than one closed path.**
- 7. Series circuit: An electric circuit in which the components are in a single path so that the current has only one closed path to follow.**
- 8. Short circuit: A path of low resistance made between two points in an electric circuit where the resistance is normally much higher.**
- 9. Variable: An element in an experiment that can be changed.**
- 10. Volt: A unit used to measure the electric potential of a battery.**
- 11. Wire: A metal strand used to connect electrical devices in a circuit**
- 12. Constant: A condition that is not changed in a scientific experiment.**



STANDARDS: Science Strand: ENERGY

Standard: FL.SC. B. 1.2.

Energy: The student recognizes that energy may be changed in form with varying efficiency.

SC.B.1.2.2

The student recognizes various forms of energy.

SC.B.1.2.3

The student knows that most objects heat emits light also emit heat.

Strand: The Nature of Science

SC.H.1.2.

The student uses the scientific processes and habits of mind to solve.

Language Arts: Writing:

LA.B.1.2

The student uses writing processes effectively.

LA.B.2.2

The student writes to communicate ideas and information effectively.

THE STUDENTS: “*Light It Up*” is designed for intermediate students of all achievement levels. Materials and procedures for this unit are based on groups of two and four. Some activities work best with a partner as other activities such as wiring a house could be done in a cooperative learning group of four. This approach provides a small forum in which students get a chance to learn from each other by sharing ideas, discoveries, and skills. This unit will help prepare students for the fifth-grade FCAT science test. “Light it Up” is designed to be taught over a nine week period, three times a week with class sessions of sixty minutes.

OVERALL VALUE: Searching for an exciting science inquiry unit that includes physical science, involves critical thinking skills and in addition will improve student writing summarizes “Light It Up”. Students are highly motivated as they are challenged to become real - world electricians working through the lessons. As a facilitator, you will feel fulfilled as your students become enthralled and engaged throughout this unit. I loved teaching this unit and know you will too!!

THE STAFF: DeeDee Conte is a gifted facilitator who has been teaching at M-DCPS schools for 25 years. In addition to teaching, DeeDee was an Educational Specialist for two years in the Division of Advance Academics M-DCPS. She has worked as an educational consultant for Carolina Biological Supply Company, conducting teacher workshops throughout the United States on best teaching practices and strategies of science inquiry, using the curriculum developed by the National Science Resource Center, “Science and Technology for Children.” She has also presented at numerous conferences at the local, state and national level in the area of both science and technology. DeeDee has received several grants from The Education Fund including Impact II Adaptor grants. For this project, you do not need any additional staff members, however about an hour is needed to prepare and strip your wires for your circuits and lessons.

RESOURCES: Materials used are simple household objects that can be found in the home or purchased at Home Depot etc. Some items such as battery and bulb holders may be purchased through Carolina Biological Supply Company. www.carolina.com 1-800-345-5551. Carolina Biological Supply Company will allow you to purchase any item piece by piece. Please use your adaptor grant money to purchase anything you might need to enhance this unit. Remember to save all your receipts.

